

LED HYBRID T8

DIRECT REPLACEMENT & BY-PASS



INSTALL INSTRUCTIONS

DANGER - RISK OF SHOCK-DISCONNECT POWER BEFORE INSTALLATION.

THIS PRODUCT MUST BE INSTALLED IN ACCORDANCE WITH THE APPLICABLE INSTALLATION CODE BY A PERSON FAMILIAR WITH THE CONSTRUCTION AND OPERATION OF THE PRODUCT AND THE HAZARDS INVOLVED.

For use as LED Luminaire Conversion Retrofit Kit

DANGER - RISK OF SHOCK-DISCONNECT POWER BEFORE INSTALLATION. The retrofit kits including Installation Instructions, LED Lamp, Luminaire Marking Labels.

The T8 LED tubes are intended to retrofit Listed surface mounted, type Non-IC or type IC recessed mounted fluorescent luminaires with or without diffuser for maximum four lamps with lamp to lamp distance 11 cm minimum; Or retrofit surface mounted Listed fluorescent luminaires without diffuser for maximum six lamps with lamp to lamp distance 5.5 cm minimum.

WARNING - Risk of fire or electric shock. The electrical rating of these products are 120-277Vac, the installer must determine whether they have 120-277V at the luminaire before installation.

WARNING - Risk of fire or electric shock. LED Retrofit Kit installation requires knowledge of luminaires electrical systems. If not qualified, do not attempt installation. Contact a qualified electrician.

WARNING - Risk of fire or electric shock. Install this kit only in the luminaires that have the construction features and dimensions shown in the photographs and/or drawings and where the input rating of the retrofit kit does not exceed the input rating of the luminaire.

WARNING - To prevent wiring damage or abrasion, do not expose wiring to edges of sheet metal or other sharp objects.

Do not make or alter any open holes in an enclosure of wiring or electrical components during kit installation.

Installers should not disconnect existing wires from lamp holder terminals to make new connections at lamp holder terminals. Instead installers should cut existing lamp holder leads away from the lamp holder and make new electrical connections to lamp holder lead wires by employing applicable connectors.

THIS RETROFIT KIT IS ACCEPTED AS A COMPONENT OF A LUMINAIRE WHERE THE SUITABILITY OF THE COMBINATION SHALL BE DETERMINED BY AUTHORITIES HAVING JURISDICTION.

DO NOT USE WITH DIMMERS.

RISK OF ELECTRIC SHOCK - USE IN DRY AND DAMP LOCATION ONLY THIS

DEVICE IS NOT INTENDED FOR USE WITH EMERGENCY EXITS

INSTALL INSTRUCTIONS: MODE 1 • DIRECT REPLACEMENT

For direct replacement for specific fluorescent lamp (32W/48T8, 30W/48T8, 28W48T8, 25W48T8), follow steps below:

1. Turn Power off
2. Remove lens or diffuser (if applicable)
3. Remove existing fluorescent lamp from the luminaire.
4. Install the LED replacement lamp (one for each fluorescent lamp removed).
6. Replace lens or diffuser back in place (if applicable)
7. Turn Power on

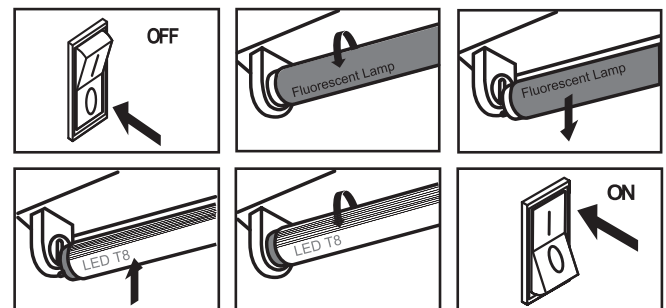

INSTALL INSTRUCTIONS: MODE 2 • BY-PASS

1. Turn Power off
2. Remove existing fluorescent tube(s), diffuser (if applicable) and open the ballast cover.
3. Disconnect luminaire supply wirings L and N to branch circuit as shown in Fig. 1.
4. Original circuit as shown in Fig. 2. Cut lampholder leads "1, 2, 3, 4, L, N," then check whether the lampholder is shunted. Cut as far away from the lampholders to allow for longer lengths of wire at both lampholders. Note: Ballast must be retained in place in accordance to UL regulations.
5. Check the lamp holders. If the lamp holders are shunted, go to Step 6. If the lamp holders are not shunted, go to Step 7. For "One End" wiring configuration only, "WARNING: To avoid potential fire or shock hazard, do not use this retrofit kit in luminaires employing shunted bi-pin lampholders. Note: Shunted lamp holders are found only in fluorescent luminaires with Instant-Start ballasts. Instant-start ballasts can be identified by the words "Instant Start" or "I.S." marked on the ballast. This designation may be in the form of a statement pertaining to the ballast itself, or may be combined with the marking for the lamps with which the ballast is intended to be used, for example F40T12/IS. For more information, contact the LED luminaire retrofit kit manufacturer.

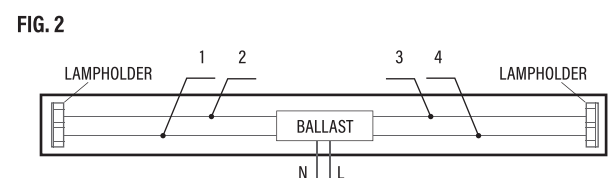

LED HYBRID T8

MODE 2 • BY-PASS



INSTALL INSTRUCTIONS

6. If the lamp holders are shunted, connect one lead from each lampholder to branch circuit as follows, "Leads 3 and 4" connected to L; "Leads 1 and 2" connected to N as shown in Fig. 3.

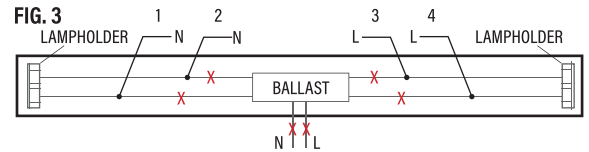

7. The lamp holders are not shunted. "One End" or "Both End" wiring can be selected. For "One End" wiring, connect one lead from each lampholder to branch circuit as follows, "Leads 1" connected to L; "Leads 2" connected to N. Don't connect Lead 3, Lead 4 to the circuit as shown in Fig. 4. Note: Leads 1 and Leads 2 are respectively connected to L and N1 on the LED tube, Don't connect N2 and N3 in the circuit.

For "Both Ends" wiring, Connect one lead from each lampholder to branch circuit as follows, "Leads 1 and Leads 2" connected to L; "Leads 3 and Leads 4" connected to N. as shown in Fig. 4A.

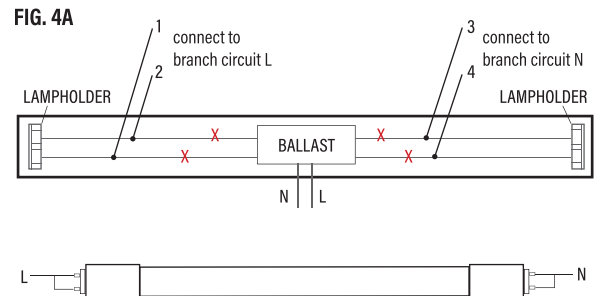
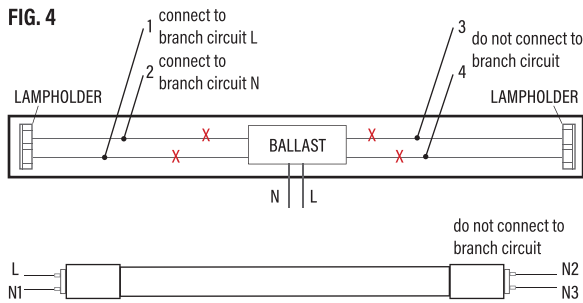

8. Attach the field applied label to the luminaire. Install ballast cover and diffuser (if applicable) back on Luminaire, and T8 LED tube as shown in Fig. 5.

9: Turn on the AC power source, LED Tube will light.

The wiring of multiple lamps is the same as above.

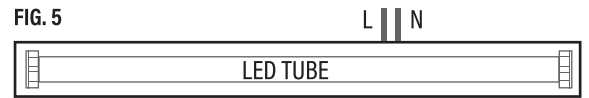

INSTALL INSTRUCTIONS - MODE 2 • BY PASS MAGNETIC BALLAST

REPEAT STEPS 1 TO 3

4. Original circuit as shown in Fig. 6. Cut lamp holder leads "1, 2, 3, 4", Cut as far away from the lampholders to allow for longer lengths of wire at both lampholders. Note: Ballast must be retained in place. Note: Ballast must be retained in place in accordance to UL regulations.

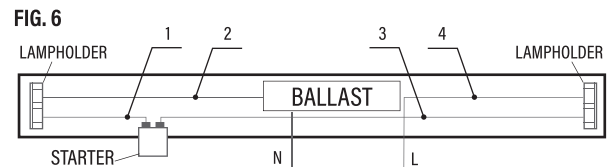

"One End" or "Both End" wiring can be selected. For "One End" wiring, connect one lead from each lampholder to branch circuit as follows, "Leads 1" connected to L; "Leads 2" connected to N. Don't connect Lead 3, Lead 4 to the circuit as shown in Fig. 7. Note: Leads 1 and Leads 2 are respectively connected to L and N1 on the Led tube, Don't connect N2 and N3 in the circuit.

For "Both Ends" wiring, Connect one lead from each lampholder to branch circuit as follows, "Leads 1 and Leads 2" connected to L; "Leads 3 and Leads 4" connected to N. as shown in Fig. 7A.

REPEAT STEPS 8 TO 9 - The wiring of multiple lamps is the same as above.

